

Gas pressure sensor DGS

OPERATING INSTRUCTIONS

Cert. Version 01.24 · Edition 04.24 · EN · 03251643



1 SAFETY

1.1 Please read and keep in a safe place



Please read through these instructions carefully before installing or operating. Following the installation, pass the instructions on to the operator. This unit must be installed and commissioned in accordance with the regulations and standards in force. These instructions can also be found at www.docuthek.com.

1.2 Explanation of symbols

1, 2, 3, a, b, c = Action

→ = Instruction

1.3 Liability

We will not be held liable for damage resulting from non-observance of the instructions and non-compliant use.

1.4 Safety instructions

Information that is relevant for safety is indicated in the instructions as follows:



DANGER

Indicates potentially fatal situations.



WARNING

Indicates possible danger to life and limb.



CAUTION

Indicates possible material damage.

All interventions may only be carried out by qualified gas technicians. Electrical interventions may only be carried out by qualified electricians.

1.5 Conversion, spare parts

All technical changes are prohibited. Only use OEM spare parts.

CONTENTS

1 Safety	1
2 Checking the usage	2
3 Installation	2
4 Electrical connection	3
5 User keys and display	3
6 LED (colour/flash code)	4
7 Operation	5
8 Changing the password	5
9 Commissioning	5
10 Tightness test	6
11 Checking the function	6
12 Accessories	6
13 Maintenance	7
14 Assistance in the event of malfunction	7
15 Technical data	9
16 Designed lifetime	10
17 Safety information in accordance with EN 61508-2	11
18 Certification	11
19 Parameter	12
20 Logistics	14
21 Disposal	14
22 Pressure units	14

2 CHECKING THE USAGE

For monitoring positive or differential pressures of gas, hydrogen, air, flue gas or other non-aggressive gases.

This function is only guaranteed when used within the specified limits – see page 9 (15 Technical data). Any other use is considered as non-compliant.

2.1 Type code

DGS	Gas pressure sensor
	Relative pressure sensor measuring range (positive pressure)
-	No sensor
100	0–100 mbar (0–40,1 "WC)
350	0–350 mbar (0–140,7 "WC)
1000	0–1000 mbar (0–401 "WC)
A	Not fail-safe (ePSD Cat-A)
C	Fail-safe (ePSD Cat-C)
	Differential pressure sensor measuring range
-	No sensor
20	0–20 mbar (0–8 "WC)
50	0–50 mbar (0–20 "WC)
100	0–100 mbar (0–40,1 "WC)
R	Rp internal thread
N	NPT internal thread
8	Electr. connection: 2 x M12 plug connectors
TX	10/100 Mbit/s (Fast Ethernet)
-M	Modbus TCP

2.2 Part designations

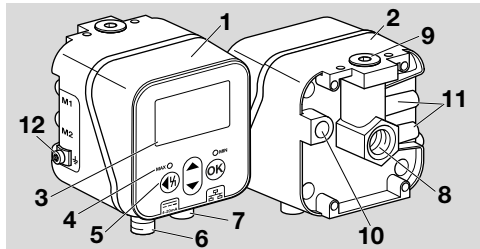

- 1 Upper housing section
- 2 Lower housing section
- 3 Display
- 4 Status display
- 5 User keys
- 6 Voltage supply/4–20 mA signal
- 7 Ethernet
- 8 P1, Rp 1/4 (1/4" NPT) gas/air connection
- 9 P2, Rp 1/4 (1/4" NPT) gas/air connection
- 10 Breather orifice
- 11 M1, M2 pressure test nipples
- 12 M4 screw terminal for device grounding

2.3 Type label

Gas type, switching pressure, max. inlet pressure, ambient temperature, mains voltage and output signals: see type label.



3 INSTALLATION

⚠ CAUTION

Please observe the following to ensure that the unit is not damaged during installation:

- Dropping the device can cause permanent damage. In this event, replace the entire device and associated modules before use.
- Use approved sealing material only.
- Continuous operation with gases containing more than 0.1 %-by-vol. H₂S or ozone concentrations exceeding 200 µg/m³ accelerate the ageing of elastomer materials and reduce the service life.
- Condensation must not be allowed to get into the housing. At subzero temperatures, malfunctions/failures due to icing can occur.
- Avoid strong impact on the unit.

3.1 Installation position

Installation in the vertical or horizontal position, not upside down. The recommended installation position is vertical.

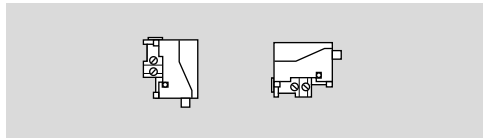

A zero point adjustment must be carried out during the commissioning or maintenance procedure to avoid discrepancies. The zero point adjustment should be carried out in normal operating temperature to obtain the best possible accuracy and reduce thermal effects.

3.2 Connections

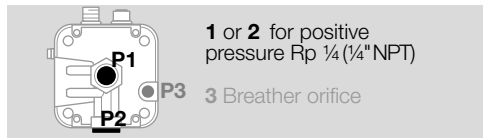

1 or 2 for positive pressure Rp 1/4 (1/4" NPT)

3 Breather orifice

Relative pressure (positive pressure)

Connect	Seal
P1	P2
P2	P1

Differential pressure

For the higher absolute pressure	For the lower absolute pressure
P1	P2

3.3 Connecting the pressure line

- 1 Disconnect the system from the electrical power supply.
 - 2 Close the gas supply.
 - 3 Ensure that the pipeline is clean.
 - 4 Purge the pipe.
- Connect the pipeline so that a clear view of the display is guaranteed.
- The image may not show the actual installation position.

Relative pressure sensor

Relative pressure (positive pressure) on port 1

→ Seal port 2.

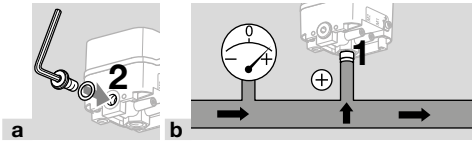

Relative pressure (positive pressure) on port 2

→ Seal port 1.

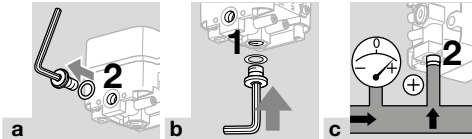

Differential pressure sensor

Port 1 for the higher absolute pressure, port 2 for the lower absolute pressure.

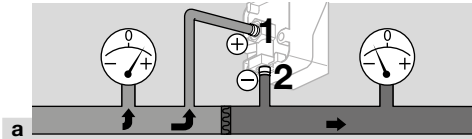

4 ELECTRICAL CONNECTION

- 1 Note the recommended tightening torques, see page 9 (15.2.1 Recommended tightening torque).

Voltage supply and 4–20 mA signal

- 2 Disconnect the system from the electrical power supply.
- Connect the 24 V DC voltage supply using the M12 connector (plug/plug, 4-pin, A-coded).

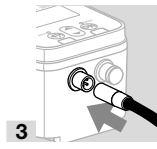
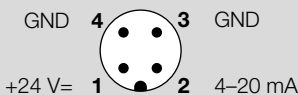

3 Communication interface (10/100 Mbit/s (Fast Ethernet))

⚠ CAUTION

Please observe the following to ensure that the DG smart is not damaged during operation:

- If the Ethernet connection is not being used, ensure that the sealing plug is still protecting the connection. Otherwise, IP 65 is no longer ensured.

If the Ethernet connection is not being used, the following steps are not necessary.

- Connect the Ethernet using the M12 connector (socket/coupling, 4-pin, D-coded).

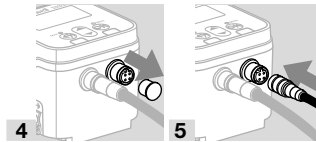
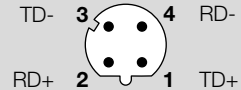

- To prevent interference signals through the Ethernet connection, we recommend that the functional earth is connected using a fine-strand cable (max. 4 mm²).

- 6 Only loosen the M4 screw terminal.

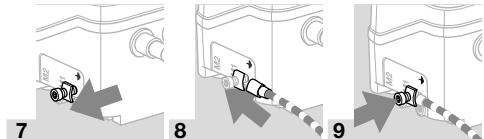

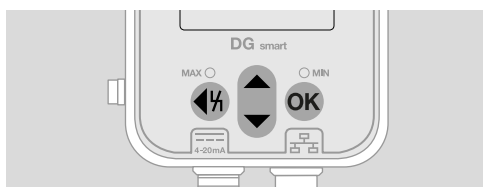

5 USER KEYS AND DISPLAY



- Recorded data, parameters, settings and notifications are output on the display in clear text. Press and hold the OK key for around 1.5 s to unlock the display and open the menu. Pressing the OK or any other key briefly will enable the backlight.

→ The user keys are used for menu navigation and parameter setting purposes.

Symbol	Description
OK	OK Press the OK key to confirm a selection or query.
	UP/DOWN navigation to navigate in the menu or to increase/reduce a value. Press and hold the key to continuously increase or reduce a value.
	Reset Press and hold the Reset key until the display is reset. Back The Back key enables you to navigate back in the menu hierarchy.

5.1 Backlight

Pressing any key for less than 0.5 s switches on the backlight. The backlight will switch off again 30 s after the last key is pressed.

6 LED (COLOUR/FLASH CODE)

Two changing colour LEDs show the status of the MAX/MIN function or a message.

→ If the MAX/MIN function is disabled, the LEDs remain off during normal operation.



Colour and flash code

→ The details refer to values which are parameterized, see [Parameters](#).

Col-our	Meaning	Mode	Description
MAX LED			
Red	Alarm	Permanent	The pressure is greater than or equal to the setting value for the "MAX alarm" NFS parameter.
Yellow	Warning	Permanent	The pressure is greater than or equal to the setting value for the "MAX warning" NFS parameter.
Green	OK	Permanent	The pressure is less than the setting values for the "MAX alarm", "MAX warning" and "MAX switching value" NFS parameters.

Col-our	Meaning	Mode	Description
Red	Recording	Flashing (1 Hz)	The pressure is greater than the setting value for the "MAX switching value" NFS parameter.
MIN LED			
Red	Alarm	Permanent	The pressure is less than or equal to the setting value for the "MIN alarm" NFS parameter.
Yellow	Warning	Permanent	The pressure is less than or equal to the setting value for the "MIN warning" NFS parameter.
Green	OK	Permanent	The pressure is greater than the setting values for the "MIN alarm", "MIN warning" and "MIN switching value" NFS parameters.
Red	Record	Flashing (1 Hz)	The pressure is less than the setting value for the "MIN switching value" NFS parameter.
MAX LED and MIN LED			
Yellow	Initializa-tion	Permanent	The unit is in Initialization mode.
Yellow	Setting the zero point	Flashing (5 Hz)	Ready for zero point adjustment (no fault may be active)
Red	Alarm	Permanent	Internal device error
Red	Overpres-sure/ Under-pressure detected	Flashing (1 Hz)	Overpressure or underpressure has been detected and the pressure is now back within the limit values (the unit must be reset and checked).
Red	Overpres-sure/ Under-pressure active	Flashing (5 Hz)	Overpressure or underpressure is active. The pressure must be shut down.
Yellow	Perma-nent remote reset	Flashing (1 Hz)	Permanent remote reset (a warning is issued only if remote reset is parameterized)
Red	Too many remote resets	Flashing (1 Hz)	Too many remote resets (a fault lock-out occurs only if remote reset is parameterized)

7 OPERATION

7.1 Status display/Locked display

The unit is in operating mode.

- The display does not have to be switched on. The current pressure value and, in certain circumstances, a message are displayed immediately.

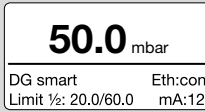

- The device name and set limit values (MIN/MAX function) are displayed in the bottom section.

Unlocking the display

- Press and hold the OK key (for around 1.5 s) to unlock the display.
- The main menu will appear in the display.
- The user keys are used for menu navigation and parameter setting purposes.
- When it is first switched on, the DG smart automatically starts operating with the previously parameterized settings or the default settings.
- Password-protected settings can be edited by logging into the DG smart or the web server. Login to edit password-protected parameters, see page 5 (8 Changing the password).

Setting using the web server, see [TI DG smart](#), section entitled “Web server”.

7.1.1 Display of bus protocol

The following is shown in the display if the Ethernet connection is active/inactive:

Eth:... = not connected

Eth:con = connected

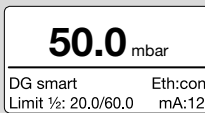

For details of the Modbus TCP, see [TI DGS](#), section entitled “Modbus holding registers”.

7.2 Main menu

Various parameters can be accessed using the following menu hierarchy.

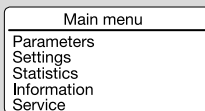

- Press the UP/DOWN keys to navigate in the menu. Press the OK key briefly to confirm your selection.
- Press the Back key briefly to return to the status display.

8 CHANGING THE PASSWORD

- 1 Select “Settings” in the main menu.

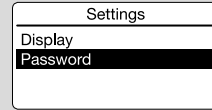

- 2 Select the “Password” parameter.

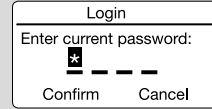

A four-digit numerical password restricts access to the unit. The password can be changed. The default value is 0000.

⚠ CAUTION

Incorrect use!

Please note the following to avoid damage:

- Change the password immediately after commissioning!

Enter the password.

- 3 Press the appropriate cursor key to change the password numbers.
 - 4 Press the OK key to confirm the number and go to edit the next entry box.
 - 5 When all 4 numbers have been set, press the OK key to save the new password.
- You can also select “Cancel” using the cursor keys and exit the input process.

9 COMMISSIONING

A zero point adjustment must be carried out at operating temperature during the commissioning process.

- 1 Vent the gas pipe.
 - 2 Read the pressure value and enter it as a negative value in Parameters -> Safety parameters. Example: read value = 0.5 mbar, enter -0.5. Enter password when prompted and press OK to confirm.
 - 3 Go to the main menu using the Back key.
- The parameters are saved and the unit is restarted.
 - The current ambient pressure will be saved as the zero point.
 - The unit is now ready for operation.

10 TIGHTNESS TEST

Check all gas ports used for tightness.

- 1 Shut off the downstream gas pipeline close to the valve.
 - 2 Open the valve and the gas supply.
- Test pressure N_2 : $< 1.5 \times$ withstand pressure for max. 15 minutes.

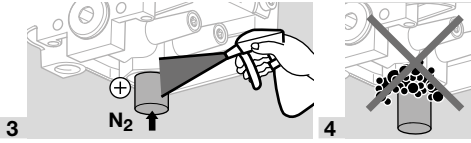

11 CHECKING THE FUNCTION

We recommend a function check once a year.

- 1 Check the transmitter and/or MIN/MAX function using the parameterized switching pressures.
- 2 Carry out a zero point adjustment at operating temperature, see page 5 (9 Commissioning).
- 3 Carry out a reference pressure measurement, see page 7 (13 Maintenance), relative and differential pressure measurement.

12 ACCESSORIES

12.1 Test key PIA

For zero point adjustment or to test the MIN function, the DG smart can be vented using the PIA test key (contains non-ferrous metals).

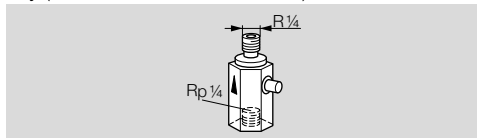

Order No.: 74329466

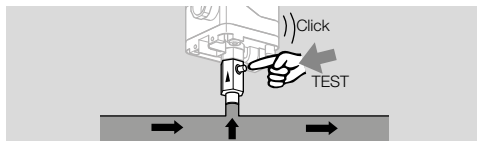

12.2 Tube set

To be used with air only.

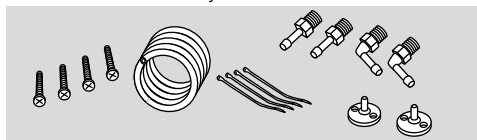

Tube set with 2 m PVC tube (\varnothing 4,75 x 1 mm), 2 duct connection flanges with screws, R 1/4 and R 1/8 connecting nipples.

Order No.: 74912952.

12.3 Connecting set for DGS and DG

A DGS used as a relative pressure sensor (positive pressure) can be connected to a pressure switch (DG..U, DG..B, DG..H, DG..N) with a mechanical switching function.

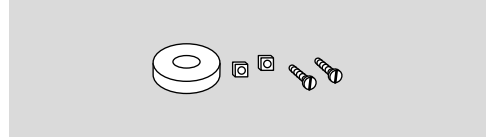

Order No.: 74912250

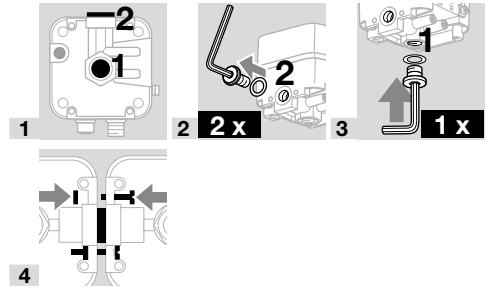

12.4 Fastening set with screws, U-shape bracket

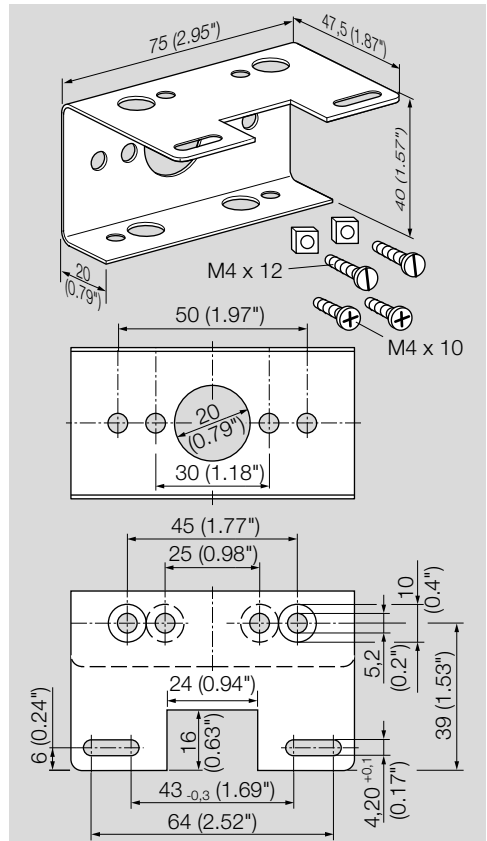

Order No.: 74915387

13 MAINTENANCE

In order to ensure smooth operation, check the tightness and function of the pressure sensor every year.

→ After carrying out the maintenance work, check for tightness.

A zero point adjustment must be carried out at operating temperature after the maintenance work has been completed to ensure the best possible accuracy.

13.1 Pressure test nipples

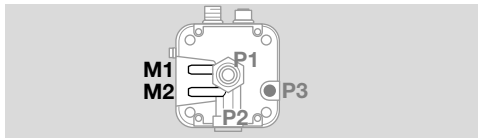

Relative pressure measurement (positive pressure)

→ The relative pressure is measured on a pressure test nipple, M1 or M2.

→ The unused pressure test nipple remains closed.

Differential pressure measurement

The differential pressure is measured on both pressure test nipples, M1 and M2.

13.2 Service

Process data are shown in the Service parameter and a firmware upgrade can be carried out. The Service parameter can only be accessed via the web server, see TI DG smart, section entitled "Web server".

Download DGS Firmware upgrade, see www.docuthek.com.

14 ASSISTANCE IN THE EVENT OF MALFUNCTION

→ The backlight switches on automatically in the event of a fault.

A warning or fault is shown in clear text in the bottom section of the display.

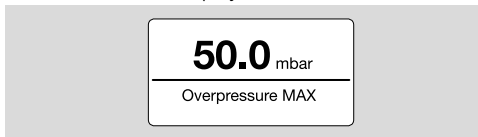

1 Press the OK button briefly (< 1.5 s) to display the fault code.

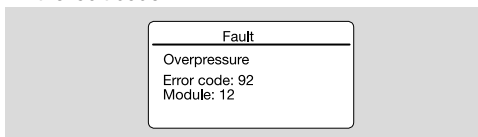

2 Press the Back key briefly to return to the status display.

14.1 Error code

Code	Module	Description
96	0	Too many remote resets
52	10	Permanent remote reset
34	10	Mains voltage
32	10	Undervoltage
33	10	Overvoltage
81	10	Warning undertemperature
80	10	Warning overtemperature
83	10	Undertemperature
82	10	Overtemperature
40	12	MIN pressure
41	12	MAX pressure
91	12	Underpressure
92	12	Overpressure
2	3	4–20 mA interrupted
3	3	4–20 mA impedance error
3/4	9	Faulty parameters
6	9	Inconsistent NFS para.
2	8	Inconsistent FS para.
99		Internal error

→ Faults may be cleared only using the measures described below.

! CAUTION

Please note the following to avoid damage:

- Fault-clearance must only be undertaken by authorized trained personnel.

→ If these measures do not help to rectify the fault: remove the unit and return it to the manufacturer for inspection.

? Faults

- ! Cause
 - Remedy

14.2 Too many remote resets

? Too many remote resets?

- ! More than 5 resets have been conducted within the last 15 minutes, either automatically or manually.
 - Consecutive fault caused by a previous fault whose actual cause has not been remedied.
- Pay attention to previous fault messages.
- Remedy cause.
- The cause will not be remedied by performing a reset every time a fault lock-out occurs.
- Check whether remote reset complies with standards (EN 746 allows resetting only under supervision) and correct if necessary.
 - Press and hold the reset key, see page 9 (14.19 Resetting).

14.3 Permanent remote reset

? Permanent remote reset?

- ! Warning: the unit is being permanently reset remotely by the bus communication.
 - Check the actuation for the remote reset and cancel the signal.

14.4 Mains voltage

? Mains voltage?

- ! The function for reading the mains voltage is defective.
 - Reset the unit once.
 - If the measure described above does not help, remove the unit and return it to the manufacturer for inspection.

14.5 Under-/Overvoltage

? Supply voltage too low/too high?

- ! Supply voltage too low ($< 24 \text{ V DC} - 20\%$) or too high ($> 24 \text{ V DC} + 20\%$).
 - Operate the unit within the permitted mains voltage range, see page 9 (15 Technical data).

14.6 Warn. Undertemp.

? Low ambient temperature warning?

- ! The ambient temperature is very low (in the range from 0 to 5°C).
 - Ensure that the ambient temperature is within the permitted range, see page 9 (15 Technical data).

14.7 Warn. Overtemp.

? High ambient temperature warning?

- ! The ambient temperature is very high (in the range from 55 to 60°C).
 - Ensure that the ambient temperature is within the permitted range, see page 9 (15 Technical data).

14.8 Undertemperature

? Ambient temperature too low?

- ! The ambient temperature is below the minimum limit for the unit ($< 0^\circ\text{C}$).
 - Ensure that the ambient temperature is within the permitted range, see page 9 (15 Technical data).

14.9 Overtemperature

? Ambient temperature too high?

- ! The ambient temperature is above the maximum limit for the unit ($> 60^\circ\text{C}$).
 - Ensure that the ambient temperature is within the permitted range, see page 9 (15 Technical data).

14.10 MIN pressure

? MIN switching pressure?

- ! The pressure has fallen below the set MIN switching pressure.
 - Ensure that the inlet pressure is at an adequate level.
 - If the MIN reset function has been parameterized (manual or remote), reset the unit.

14.11 MAX pressure

? MAX switching pressure?

- ! The pressure has exceeded the set MAX switching pressure.
 - Ensure that the inlet pressure is within the permitted range.
 - If the MAX reset function has been parameterized (manual or remote), reset the unit.

14.12 Underpressure

? Underpressure?

- ! Underpressure has been detected. The pressure is below the permitted measuring range.
- The unit has been operated outside the technical limits and may be damaged.
 - Test the function to ensure that the unit is operating perfectly.
 - Ensure that the inlet pressure is within the permitted range. Then reset the unit.

14.13 Overpressure

? Overpressure?

- ! Overpressure has been detected. The pressure is above the permitted measuring range.
- The unit has been operated outside the technical limits and may be damaged.
 - Test the function to ensure that the unit is operating perfectly.
 - Ensure that the inlet pressure is within the permitted range. Then reset the unit.

? 4–20 mA interrupted?

- ! 4–20 mA signal missing/interrupted.
 - Check and/or establish the connection for the 4–20 mA signal. See page 3 (4 Electrical connection).

14.14 4–20 mA impedance error

? 4–20 mA signal impedance error?

- ! Excessive impedance (internal network resistance) in the measuring system.
 - Check the measuring impedance, see 4–20 mA output signal load impedance, page 9 (15.3 Electrical data).

14.15 Faulty parameters

? Faulty parameters?

- Check parameter settings and adjust them if necessary.

14.16 Inconsistent FS para.

? Inconsistent safety parameter?

! An inconsistent safety parameter has been identified.

- Check the parameter set and edit it if necessary.

14.17 Inconsistent NFS para.

? Inconsistent non-safety parameter?

! An inconsistent non-safety parameter has been identified.

- Check the parameter set and edit it if necessary.

14.18 Internal error

? Internal device error?

! An internal device error occurred.

- Reset the unit once.
- If the measure described above does not help, remove the unit and return it to the manufacturer for inspection.

14.19 Resetting

→ Mains voltage is switched on.

Press and hold the Reset key until the display is reset.

Resetting faults:

Press and hold the reset key for at least 0.5 s.

14.20 Restoring factory settings



CAUTION

Data loss!

All customer parameter assignments and the firmware are reset to default settings.

1 Press and hold both cursor keys when the mains voltage is switched on (POWER ON) until "Upgrading MCA..." appears in the display.

2 Release the cursor keys.

→ The reset may take up to 5 minutes.

15 TECHNICAL DATA

15.1 Ambient conditions

Icing, condensation and dew in and on the unit are not permitted.

Medium and ambient temperatures during operation (to EN 1854:2022+A1:2023 and FM 3510): 0 to 60°C (32 to 140°F).

Extended medium and ambient temperature range: -20 to +70°C (4 to 158°F). In extended temperature ranges, outside the range from 0 to 60°C (32 to 140°F), an increased measuring deviation must be expected (up to 0.5% FS/K) and the DG smart no longer satisfies the accuracy requirements set out in EN 1854:2022+A1:2023 and FM 3510.

Long-term use in the upper ambient temperature range accelerates the ageing of the elastomer materials and reduces the service life (please contact manufacturer).

Storage and transport temperatures: -20 to +60°C (4 to 140°F).

Avoid direct sunlight or radiation from red-hot surfaces on the unit. Note the maximum medium and ambient temperatures!

Avoid corrosive influences, e.g. salty ambient air or SO₂.

The unit may only be stored/installed in enclosed rooms/buildings.

The unit is suitable for a maximum installation height of 2000 m AMSL.

Enclosure: IP 65.

This unit is not suitable for cleaning with a high-pressure cleaner and/or cleaning products.

15.2 Mechanical data

Gas types for relative pressure sensor: natural gas, town gas, LPG (gaseous), flue gas, biogas (max. 0.1 %-by-vol. H₂S), hydrogen and air.

Gas types for differential pressure sensor: air.

The gas must be clean and dry in all temperature conditions and must not contain condensate.

Max. inlet pressure p_{max} = withstand pressure, measuring range and max. deviations, see page 10 (15.4 Measuring range).

Maximum leakage rate Q_L = max. 20 cm³/h.

Upper housing section: steel fibre reinforced PBT plastic with low gas release.

Lower housing section: AlSi 12.

Rp 1/4 (1/4" NPT) connecting thread.

Weight: 450 g.

15.2.1 Recommended tightening torque

Component	Tightening torque [Ncm]
Rp 1/4 (1/4" NPT) connection on aluminium lower section	1000
T15 test point screw	150
T20 ground screw	100
M12 x 1 protective cap	60

15.3 Electrical data

100% duty cycle (continuous operation).

Safety class: 3.

DGS..A (ePSD Cat A): non-fail-safe regulating and control functions.

DGS..C (ePSD Cat C): fail-safe regulating and control functions.

Mains voltage: 24 V DC, ±20%, SELV/PELV, power: ≥ 5 W.

Power consumption: < 2.5 W.

Overvoltage category III.

Communication interface: 10/100 Mbit/s (Fast Ethernet).

Bus protocol: Modbus TCP.

Electrical connection

Voltage supply and 4–20 mA signal: M12 connector (plug/plug, 4-pin, A-coded).

4–20 mA output signal load impedance: ≤ 500 Ω.

Ethernet: M12 connector (socket/coupling, 4-pin, D-coded).

Cable cross-section: min. 0.34 mm² (AWG 22), max. 1.0 mm² (AWG 17, depending on the connector used).

Functional earth: ground terminal for connecting fine-strand cables up to 4 mm².

Internal fuse: non-replaceable fuse (slow-acting, 250 mA).

15.3.1 Output signal coding

NAMUR

NAMUR NE 43 (standardization of the signal level for the failure information of digital transmitters with an analogue output signal) is used as a reference for error information (in addition to the measuring information).

Current range [mA]	Description
22.0	Overpressure detected
21.0	MAX switching pressure detected
21.0	Upper error range
20.5	Upper tech range
20.0	Upper nominal range
4.0	Lower nominal range
3.8	Lower tech range
3.6	Lower error range
3.0	MIN switching pressure detected
2.0	Over-/undervoltage or over-/undertemperature detected
1.0	Underpressure detected
0	Output off (internal or device error)

4–20 mA

The 4–20 mA output supplies the current pressure in the form of an analogue value. Any error state corresponds to 0 mA here.

The pressure measuring range is scaled to 4–20 mA.

15.4 Measuring range

Relative pressure (positive pressure)

Measuring range	Withstand pressure	MAX/MIN switching point range
0–10 kPa (0–100 mbar)	60 kPa (600 mbar)	1.1–10 kPa (11–100 mbar)
0–35 kPa (0–350 mbar)	60 kPa (600 mbar)	2.4–35 kPa (24–350 mbar)
0–100 kPa (0–1000 mbar)	150 kPa (1500 mbar)	6.7–100 kPa (67–1000 mbar)

Sensor type: Stainless steel, media-insulated.

15.4.1 Overall accuracy to

EN 1854:2022+A1:2023

Measuring range	25°C [% FSO]*	0–60°C [% FSO]	-20–0°C, 60–70°C [% FSO]
0–10 kPa (0–100 mbar)	≤ ±0.5	≤ ±1.7	≤ ±1.0
0–35 kPa (0–350 mbar)	≤ ±0.5	≤ ±1.0	≤ ±0.5
0–100 kPa (0–1000 mbar)	≤ ±0.2	≤ ±1.0	≤ ±0.5

* Includes repeat accuracy, hysteresis and linearity using the limit point method.

The overall accuracy E of a specific inlet pressure is calculated on the basis of various factors.

$$E = (\sqrt{E_R^2 + E_H^2 + E_D^2 + E_{Temp}^2 + E_L^2 + E_T^2 + E_O^2 + E_S^2}) \pm E_{Res}$$

Factors		[% FSO]		
		0–100 mbar	0–350 mbar	0–1000 mbar
E _R	Repeat accuracy	0.13	0.06	0.06
E _H	Hysteresis	0.13	0.06	0.06
E _D	Deviation	0.25	0.19	0.13
E _{Temp}	Temperature sensitivity	1.50	0.69	0.75
E _L	Linearity	0.23	0.44	0.13
E _T	Transfer ratio (4–20 mA)	0.15	0.14	0.10
E _O	Offset	0.38	0.31	0.06
E _S	Changes in supply voltage	0.06	0.06	0.06
E _{Res}	Resolution (4–20 mA)	0.03	0.03	0.03

15.4.2 Relevant times to EN 1854:2022+A1:2023

Maximum response time: < 0.5 s, fault reaction time: < 0.3 s.

16 DESIGNED LIFETIME

This information on the designed lifetime is based on using the product in accordance with these operating instructions. Once the designed lifetime has been reached, safety-relevant products must be replaced.

Designed lifetime (based on date of manufacture) in accordance with EN 1854:2022+A1:2023 for DG smart: 10 years.

You can find further explanations in the applicable rules and regulations and on the afecor website (www.afecor.org).

This procedure applies to heating systems. For thermoprocessing equipment, observe local regulations.

17 SAFETY INFORMATION IN ACCORDANCE WITH EN 61508-2

Technical Information bulletin, see www.docuthek.com, DG smart, [Safety information in accordance with EN 61508-2](#).

18 CERTIFICATION

18.1 Certificate download

Certificates – see www.docuthek.com

18.2 Declaration of conformity



We, the manufacturer, hereby declare that the product DG smart with product ID No. CE-0085DP0152 complies with the requirements of the listed Directives and Standards.

Directives:

- 2014/30/EU – EMC
- 2011/65/EU – RoHS II
- 2015/863/EU – RoHS III

Regulation:

- (EU) 2016/426 – GAR

Standards:

- EN 1854:2022+A1:2023
- EN 60730-1:2016 + A1:2019 + A2:2022
- EN 60730-2-6:2016 + A1:2020
- EN 61508:2010, suitable for SIL 2

The relevant product corresponds to the tested type sample.

The production is subject to the surveillance procedure pursuant to Regulation (EU) 2016/426 Annex III Module D.

Elster GmbH

→ Pursuant to Article 4 paragraph 3 of the Pressure Equipment Directive (PED) 2014/68/EU, the device is not governed by the Pressure Equipment Directive.

18.3 IEC



The product DG smart complies with the listed Standards:

- IEC 60730-1:2022
- IEC 60730-2-6:2015 + AMD1:2019

18.4 SIL



For systems up to SIL 2 pursuant to IEC 61508.

Safety-specific characteristic values

Diagnostic coverage DC	91%
Type of subsystem	Type B to IEC 61508-2:2010
Mode of operation	High demand mode pursuant to IEC 61508-4:2010
Mean probability of dangerous failure PFH _D	19.2 × 10 ⁻⁹ 1/h
Mean time to dangerous failure MTTF _d	1/PFH _D
Safe failure fraction SFF	94.7%

18.5 REACH Regulation

The device contains substances of very high concern which are listed in the Candidate List of the European REACH Regulation No. 1907/2006. See Reach list HTS at www.docuthek.com.

18.6 China RoHS

Directive on the restriction of the use of hazardous substances (RoHS) in China. Scan of the Disclosure Table China RoHS2, see certificates at www.docuthek.com.

19 PARAMETER

19.1 General

The “Parameters” menu option is divided into “Safety parameters” (password-protected) and “Non-safety parameters”.

The value ranges of the parameters can be edited on the DG smart or using the integral web server.

For details of the web server, see [TI DG smart, Web server](#).

For details of the value range of the parameters, see [TI DG smart, Parameters](#).

19.2 Safety parameters

All safety parameters are password-protected. The user must be logged in to edit them.

Name	Translation	Value range	Factory default settings
Sensor function	Sensor function	Transmitter MIN MAX MAX and MIN function	Transmitter
MAX switching value	MAX switching value	Setting	0 mbar
MIN switching value	MIN switching value	Setting	0 mbar
MAX reset	MAX reset	Automatic Manual Remote	Automatic
MIN reset	MIN reset	Automatic Manual Remote	Automatic
MAX delay time	MAX delay time	Setting	0 s
MIN delay time	MIN delay time	Setting	0 s
Overpressure value	Overpressure	Setting	100% of the measuring range
Zero adjustment	Zero adjustment	Setting	0 mbar
Output settings	Output settings	Inactive NAMUR 4–20 mA	NAMUR
Filter time	Time to determine the pressure	0...3 s	0 s

19.3 Non-safety parameters

Name	Translation	Value range	Factory default settings
MAX warning	MAX warning	Setting	0 mbar
MAX alarm	MAX alarm	Setting	0 mbar
MIN warning	MIN warning	Setting	0 mbar
MIN alarm	MIN alarm	Setting	0 mbar
Communication	Communication	IP address* Netmask* Gateway address* MAC address*	192.168.0.200

* Login required.

19.4 Settings

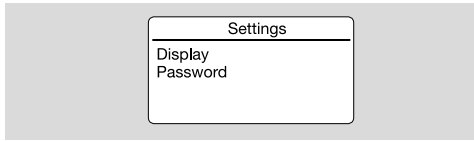

Display

Name	Translation	Value range	Factory default settings
<u>M</u> easuring unit	Measuring unit	mbar, kPa, PSI, inch WC	mbar
<u>D</u> ecimal separator	Decimal separator	Point "." or comma ","	Point "."
<u>B</u> rightness	Brightness	Setting: Display brightness	100%
<u>T</u> emperature unit	Temperature unit	C, F, K	C
<u>L</u> anguage	Language	English	English

Password

Display	Translation	Value range	Factory default settings
<u>P</u> assword	Password	xxxx	0000

19.5 Statistics

Name	Translation	Value range
<u>E</u> vent history <u>D</u> evice statistics <u>C</u> ustomer statistics	Event history Device statistics Customer statistics	Information on the event history, device statistics and customer statistics is displayed in plain text.
<u>C</u> lear event history*	Clear event history	Resetting the event history
<u>C</u> lear customer statistics*	Clear customer statistics	Resetting the customer statistics

* Login required.

19.6 Information

Name	Translation	Value range
<u>D</u> evice name <u>N</u> etwork <u>F</u> irmware	Gerätname Network Firmware	The device name, network configuration and firmware are displayed in plain text.

19.7 Service

Name	Value range
<u>F</u> irmware upgrade	Firmware upgrade

20 LOGISTICS

Transport

Protect the unit from external forces (blows, shocks, vibration).

Transport temperature: see page 9 (15 Technical data).

Transport is subject to the ambient conditions described.

Report any transport damage on the unit or packaging without delay.

Check that the delivery is complete.

Storage

Storage temperature: see page 9 (15 Technical data).

Storage is subject to the ambient conditions described.

Storage time: 6 months in the original packaging before using for the first time. If stored for longer than this, the overall service life will be reduced by the corresponding amount of extra storage time.

21 DISPOSAL

Devices with electronic components:

WEEE Directive 2012/19/EU – Waste Electrical and Electronic Equipment Directive



At the end of the product life (number of operating cycles reached), dispose of the packaging and product in a corresponding recycling centre. Do not dispose of the unit with the usual domestic refuse.

Do not burn the product.

On request, old units may be returned carriage paid to the manufacturer in accordance with the relevant waste legislation requirements.

22 PRESSURE UNITS

mbar	Pa	kPa	"WC
1	100	0.1	0.4

FOR MORE INFORMATION

The Honeywell Thermal Solutions family of products includes Honeywell Combustion Safety, Eclipse, Exothermics, Hauck, Kromschroder and Maxon. To learn more about our products, visit ThermalSolutions.honeywell.com or contact your Honeywell Sales Engineer.

Elster GmbH
Strotheweg 1, D-49504 Lotte
T +49 541 1214-0
hts.lotte@honeywell.com
www.kromschroeder.com

Global centralized service deployment coordination:
T +49 541 1214-365 or -555
hts.service.germany@honeywell.com

Translation from the German
© 2024 Elster GmbH

Honeywell
kromschroder